

CHANGE VERSION		REMARKS	C
A	16/12/20	REL	D
B	17/07/18	ADD P/N	E

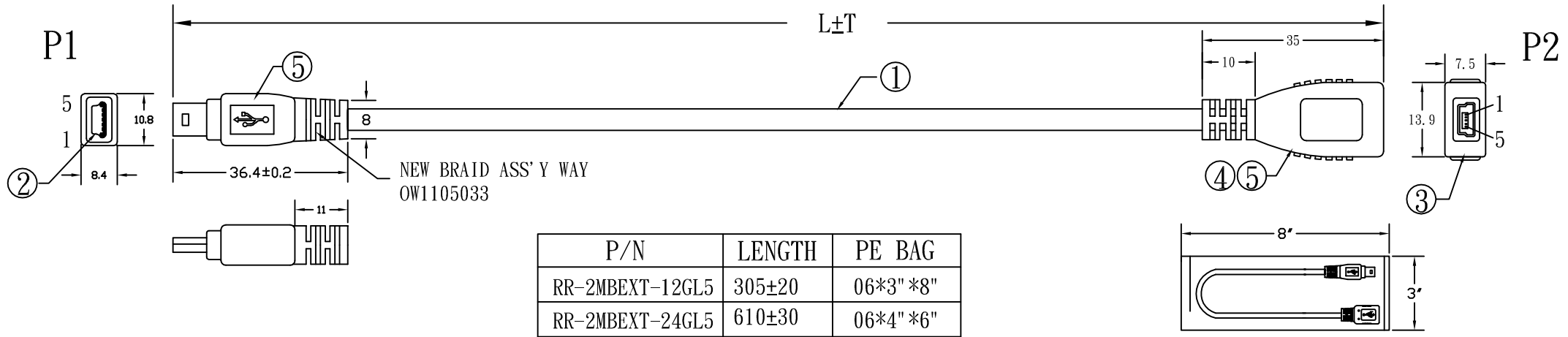

P/N	LENGTH	PE BAG
RR-2MBEXT-12GL5	305±20	06*3" *8"
RR-2MBEXT-24GL5	610±30	06*4" *6"

PIN OUT :

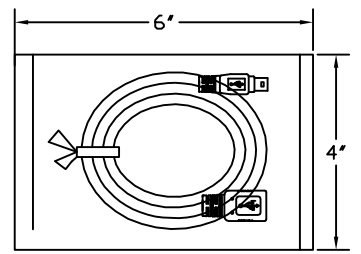
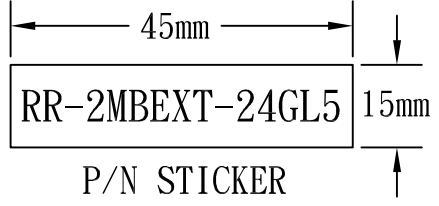
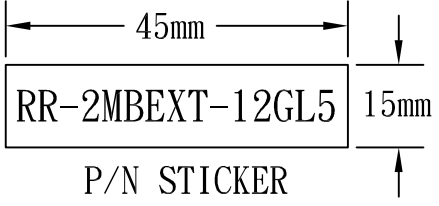
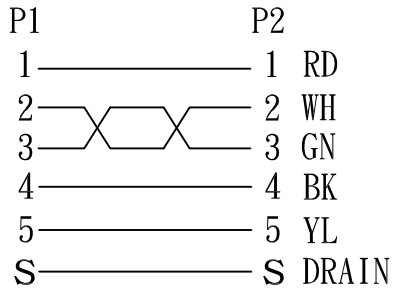

MATERIAL LIST :

NO.	P/NAME	DESCRIPTION	Q' TY
1	WIRE	UL2725 28AWG(7/0.12 TC)*1P+24AWG(7/0.20 TC)*3C+AL+1(TC)+B(16*4/0.10 TC) OD:5.0±0.15 L:290MM BLACK(B792) (COPARTNER)	1
2	PLUG	MINI USB"B" TYPE 5PIN MALE GOLD PLATED	1
3	PLUG	MINI USB"B" TYPE 5P FEMALE GOLD PLATED	1
4	PVC	LD PE	2g
5	PVC	45P BLACK(B792)PVC	15g
6	PACK	1PCE/PE BAG:06*A"*B"+ P/N STICKER	1

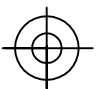
MOLD TOOL NO.	 <p>THE INFORMATION CONTAINED HEREIN IS THE PROPRIETARY INFORMATION OF RR BUSINESS VENTURES, LLC. THE POSSESSOR AGREES TO MAINTAIN THIS DOCUMENT IN CONFIDENCE; NOT REPRODUCE IT OR COPY IT, AND NOT TO REVEAL OR PUBLISH IT IN WHOLE OR PART. COPYRIGHT © 2019</p>		
MINI USB 5P M A110-536-001	SCALE	UNIT	REV
MINI USB F B120-448-001 A110-721-001		MM	B
HOOD G160-038-001	FILE NAME	CUSTOMER	
	OW1612007		
	DATE	CUSTOMER P/N	
	17/07/18		

<b>RoHS</b>	
DRAWN BY	
Marcos	
CHECKED BY	
CONFIRMED BY	
CHECKED BY	
APPROVED BY	