

REV	ECN#	DESCRIPTION OF REVISION	DRAW BY DATE	CHECK BY DATE	APPROVE BY DATE
A4	ECN-180816	RR-MRCH-XXGRC->RR-MRCH-XXGRA	Lucas 08/14/18	Lucas 08/14/18	Ray 08/14/18

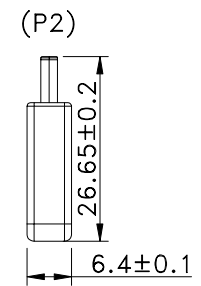
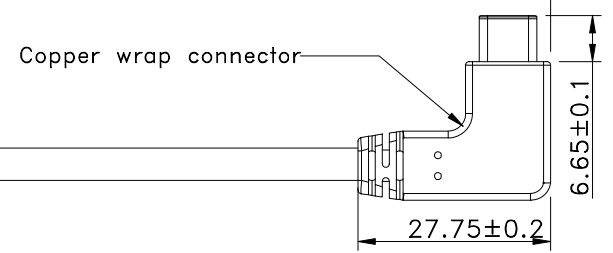
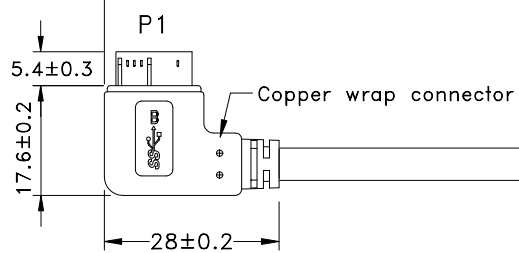
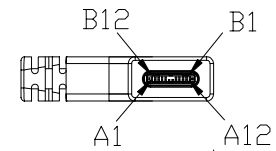
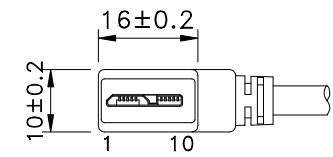

Micro-USB 3.0 BM
RIGHT ANGLE RIGHT
MOLDED BLACK

USB TYPE C M
RIGHT ANGLE RIGHT/LEFT
MOLDED BLACK

PIN OUT

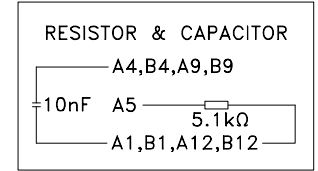
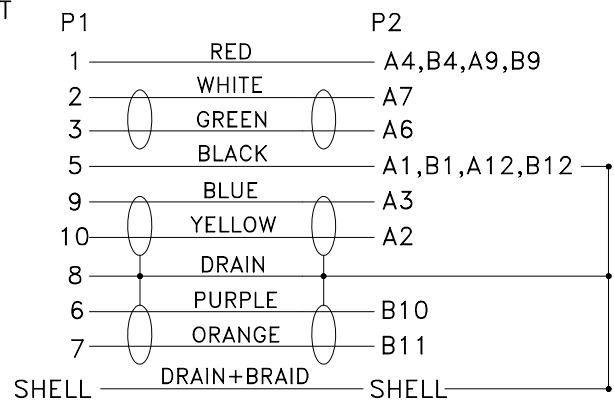

DOC.CENTER.ISSUE
AUG.15.2018
ONLY FOR
RELEASE

P/N	LENGTH
RR-MRCH-05GRA	127 ⁺²⁰ ₋₀
RR-MRCH-10GRA	255 ⁺²⁰ ₋₀
RR-MRCH-15GRA	381 ⁺³⁰ ₋₀
RR-MRCH-25GRA	635 ⁺³⁰ ₋₀
RR-MRCH-40GRA	1016 ⁺⁴⁰ ₋₀

TITLE						DRAWING NUMBER				REV.	
USB3.0 Micro-BM RIGHT-ANGLE RIGHT TO USB3.1 C TYPE MALE RIGHT ANGLE RIGHT/LEFT						RR-MRCH-XXGRA				A4	
	B	1:1	Lucas 12/28/15	Ray 12/28/15	Ray 12/28/15	X.X	± 0.5	X.XXX	± 0.05	mm	1/3
THIRD ANGLE PROJECTION	SIZE	SCALE	DRAW / DATE	CHECK / DATE	APPROVE / DATE	TOLERANCES			UNIT	SHEET	

THE INFORMATION CONTAINED HEREIN IS THE PROPRIETARY INFORMATION OF RR BUSINESS VENTURES, LLC. THE POSSESSOR AGREES TO THE FOLLOWING:

1. MAINTAIN THIS DOCUMENT IN CONFIDENCE
2. NOT TO REPRODUCE OR COPY IT
3. NOT TO REVEAL OR PUBLISH IT IN WHOLE OR IN PART

COPYRIGHT © 2019

1

2

3

4

REV	ECN#	DESCRIPTION OF REVISION	DRAW BY DATE	CHECK BY DATE	APPROVE BY DATE
A4	ECN-180816	RR-MRCH-XXGRC=>RR-MRCH-XXGRA	Lucas 08/14/18	Lucas 08/14/18	Ray 08/14/18

***CONSTRUCTION:

1.CABLE: * UL2725 (1P/30#+EAM)*2+(1P/30#)+(2C/24#)+AEB(AL)65% OD:5.0mm
BLACK PVC JACKET.

***CONNECTOR:

2.Micro-USB B/M: * MICRO-USB B "3.0" TYPE 10PIN MALE SOLDER TYPE.(SWEETRAY P/N:CHMICROUSB3BM01E)
* PINS: 30u GOLD PLATED OVER NICKEL.
* SHELL: STEEL WITH GOLD FLASH .
* INSULATOR: BLACK COLOR P.B.T UL 94V-0 RATED.
* MOLDED BLACK PVC 45P.

3.USB C/M: * USB TYPE C MALE SOLDER TYPE.
* PINS: 30u GOLD PLATED OVER NICKEL.
* INSULATOR: BLACK THERMOPLASTIC UL 94V-0.
* SHELL: STEEL WITH GOLD FLASH.
* RESISTOR(5.1KΩ) AND CAPACITOR(10nF 30V).
* MOLDED: BLACK PVC 45P.

4.TEST: * CT: 2 ohm IS: 5M ohm DC300V 0.1S.

5.PACKING: * PACK EACH CABLE IN A POLY BAG AND 25PCS IN A POLY BAG.

6.MATERIAL: * MATERIAL WITH RoHS GRADE.



TITLE USB3.0 Micro-BM RIGHT-ANGLE RIGHT TO USB3.1 C TYPE MALE RIGHT ANGLE RIGHT/LEFT				DRAWING NUMBER RR-MRCH-XXGRA				REV. A4	
---	--	--	--	---------------------------------	--	--	--	------------	--

	B	1:1	Lucas 12/28/15	Ray 12/28/15	Ray 12/28/15	XX ± 0.5 X.XX ± 0.2	XXX ± 0.05 ANGLES ± 1°	mm	2/3
THIRD ANGLE PROJECTION	SIZE	SCALE	DRAW / DATE	CHECK / DATE	APPROVE / DATE	TOLERANCES		UNIT	SHEET

THE INFORMATION CONTAINED HEREIN IS THE PROPRIETARY INFORMATION OF RR BUSINESS VENTURES, LLC. THE POSSESSOR AGREES TO THE FOLLOWING

1. MAINTAIN THIS DOCUMENT IN CONFIDENCE
2. NOT TO REPRODUCE OR COPY IT
3. NOT TO REVEAL OR PUBLISH IT IN WHOLE OR IN PART

COPYRIGHT © 2019

1

2

3

4