

1

2

3

4

Note: Max. Torque: 1 in-lb For Screws

REV	ECN#	DESCRIPTION OF REVISION	DRAW BY DATE	CHECK BY DATE	APPROVE BY DATE
A3	ECN-210221	Cable Length Change To Tip to Tip	Lucas 02/26/21	Lucas 02/26/21	Ray 02/26/21

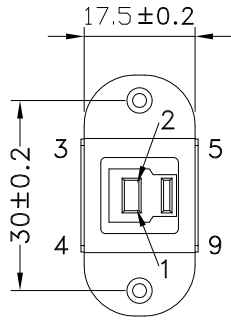

FRONT VIEW

USB B 3.0 FEMALE
MOLDED BLACK

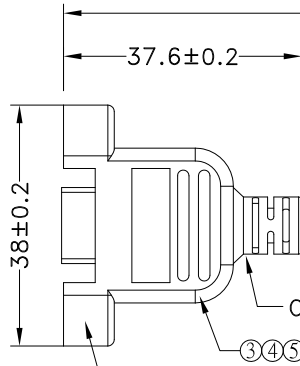

Copper wrap connector

Nut Inside, Thread size: #4-40 UNC

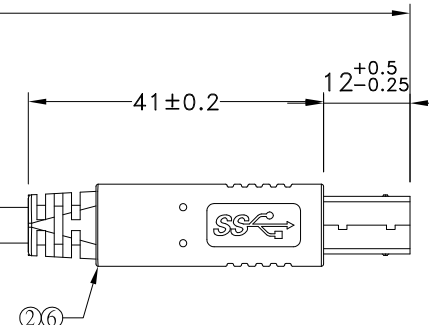

USB B 3.0 MALE
MOLDED BLACK

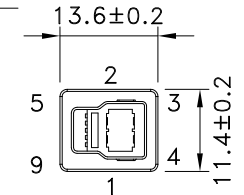

FRONT VIEW

PIN OUT

USB B F		USB B M
1	RED	1
2	WHITE	2
3	GREEN	3
4	BLACK	4
5	BLUE	5
6	YELLOW	6
7	DRAIN	7
8	PURPLE	8
9	ORANGE	9
	BRAID	
SHEEL		SHEEL

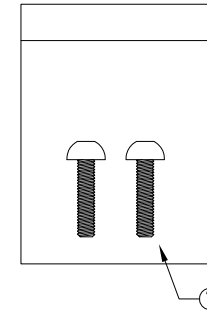

GTC
DOC.CENTER.ISSUE
MAY.13.2024
ONLY FOR
RELEASE

P/N	LENGTH
RR-BMBFPM-06GR	153 ⁺²⁰ ₋₀
RR-BMBFPM-10GR	255 ⁺²⁰ ₋₀
RR-BMBFPM-20GR	508 ⁺³⁰ ₋₀
RR-BMBFPM-24GR	610 ⁺³⁰ ₋₀
RR-BMBFPM-36GR	915 ⁺⁴⁰ ₋₀
RR-BMBFPM-72GR	1828 ⁺⁶⁰ ₋₀

TITLE USB3.0 B TYPE FEMALE TO USB3.0 B TYPE MALE						DRAWING NUMBER RR-BMBFPM-XXGR			REV. A3		
	B	1:1	Lucas 08/21/14	Ray 08/21/14	Ray 08/21/14	X.X X.XX	± 0.5 ± 0.2	X.XXX ANGLES	± 0.05 ± 1°	mm	1/3
THIRD ANGLE PROJECTION	SIZE	SCALE	DRAW / DATE	CHECK / DATE	APPROVE / DATE	TOLERANCES			UNIT	SHEET	

USB FIREWIRE.com

THE INFORMATION CONTAINED HEREIN IS PROPRIETARY AND CONFIDENTIAL TO RR BUSINESS VENTURES, LLC. THE POSSESSOR AGREES TO THE FOLLOWING

1. MAINTAIN THIS DOCUMENT IN CONFIDENCE
2. NOT TO REPRODUCE OR COPY IT
3. NOT TO REVEAL OR PUBLISH IT IN WHOLE OR PART

1

2

3

4

1

2

3

4

REV	ECN#	DESCRIPTION OF REVISION	DRAW BY DATE	CHECK BY DATE	APPROVE BY DATE
A3	ECN-210221	Cable Length Change To Tip to Tip	Lucas 02/26/21	Lucas 02/26/21	Ray 02/26/21

ITEM	Part name	MATERIAL/FINISH	Q,ty
1	Cable	UL2725 (1PR/28#+EAM)*2+(1PR/28#+A)+2C/24#+AB85% OD:5.5mm BLACK PVC JACKET	1
2	USB 3.0 BM	USB3.0 B TYPE 9PIN MALE SOLDER TYPE	1
		PINS: 30u GOLD PLATED OVER NICKEL	
		INSULATOR: BLUE COLOR P.B.T UL 94V-0 RATED	
		SHELL: STEEL WITH GOLD FLASH	
3	USB 3.0 BF	USB 3.0 B TYPE FEMALE SOLDER TYPE	1
		PINS: 30u GOLD PLATED OVER NICKEL	
		INSULATOR: BLUE COLOR P.B.T UL 94V-0 RATED	
		SHELL: BRASS WITH GOLD FLASH	
4	inner Mold	HD-PE	AR
5	Over Mold	BLACK PVC 30P	AR
6	Over Mold	BLACK PVC 45P	AR
7	SCREW	#4-40UNC 4.75x1.8mm	2
8	NUT	5.0*11mm	2
9	Copper foil	Copper foil	AR

GTC
DOC.CENTER.ISSUE
MAY.13.2024
ONLY FOR
RELEASE

TITLE USB3.0 B TYPE FEMALE TO USB3.0 B TYPE MALE					DRAWING NUMBER RR-BMBFPM-XXGR			REV. A3	
	B	1:1	Lucas 08/21/14	Ray 08/21/14	Ray 08/21/14	X.X ± 0.5 X.XX ± 0.2	X.XXX ± 0.05 ANGLES ± 1°	mm	2/3
THIRD ANGLE PROJECTION	SIZE	SCALE	DRAW / DATE	CHECK / DATE	APPROVE / DATE	TOLERANCES		UNIT	SHEET

USB FIREWIRE.com

THE INFORMATION CONTAINED HEREIN IS PROPRIETARY AND CONFIDENTIAL TO RR BUSINESS VENTURES, LLC. THE POSSESSOR AGREES TO THE FOLLOWING

1. MAINTAIN THIS DOCUMENT IN CONFIDENCE
2. NOT TO REPRODUCE OR COPY IT
3. NOT TO REVEAL OR PUBLISH IT IN WHOLE OR PART

1

2

3

4

1

2

3

4

REV	ECN#	DESCRIPTION OF REVISION	DRAW BY DATE	CHECK BY DATE	APPROVE BY DATE
A3	ECN-210221	Cable Length Change To Tip to Tip	Lucas 02/26/21	Lucas 02/26/21	Ray 02/26/21

P/N	LENGTH(mm)	PE BAG(inch)	PACKAGE
RR-BMBFPM-06GR	153 ⁺²⁰ ₀	5.5"*10	(1)
RR-BMBFPM-10GR	255 ⁺²⁰ ₀	5.5"*10	(2)
RR-BMBFPM-20GR	508 ⁺³⁰ ₀	5.5"*10	(2)
RR-BMBFPM-24GR	610 ⁺³⁰ ₀	5.5"*10	(2)
RR-BMBFPM-36GR	915 ⁺⁴⁰ ₀	5.5"*10	(2)
RR-BMBFPM-72GR	1828 ⁺⁶⁰ ₀	5.5"*10	(3)

PE BAG LABEL

RR-BMBFPM-XXGR REV:XX
 LOT: XXXX
 Made in China

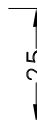

RR-BMBFPM-XXGR REV:XX QTY:25PCS
 LOT: XXXX
 Made in China

RoHS LABEL

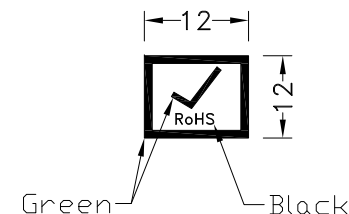

NOTES:PACK EACH CABLE IN A POLY BAG AND 25PCS IN A POLY BAG.

PACK(1)

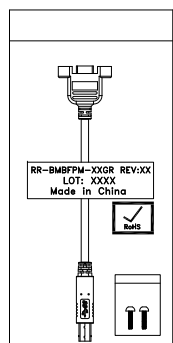

PACK(2)

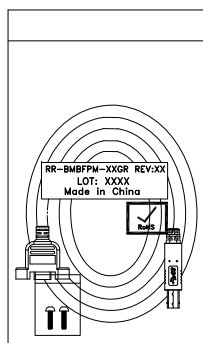

PACK(3)

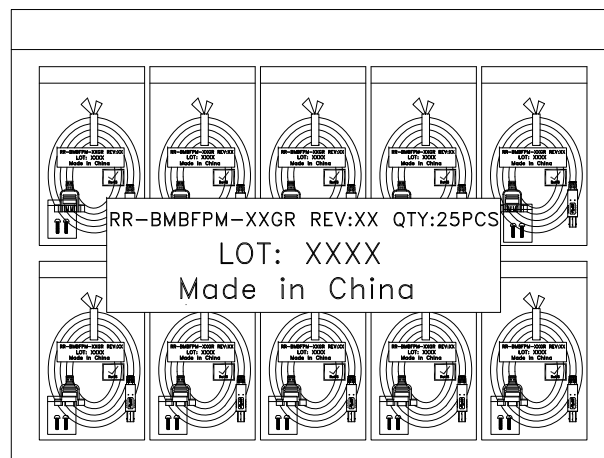
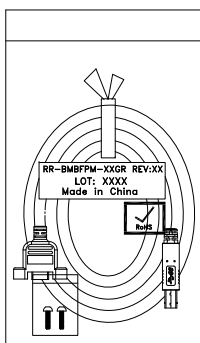

GTC
 DOC.CENTER.ISSUE
 MAY.13.2024
 ONLY FOR
 RELEASE

TITLE: USB3.0 B TYPE FEMALE TO USB3.0 B TYPE MALE
 DRAWING NUMBER: RR-BMBFPM-XXGR
 REV.: A3

THIRD ANGLE PROJECTION	SIZE	SCALE	DRAW / DATE	CHECK / DATE	APPROVE / DATE	TOLERANCES	UNIT	SHEET
	B	1:1	Lucas 08/21/14	Ray 08/21/14	Ray 08/21/14	X.X ± 0.5 X.XX ± 0.2	mm	3/3
						X.XXX ± 0.05 ANGLES ± 1°		

THE INFORMATION CONTAINED HEREIN IS PROPRIETARY AND CONFIDENTIAL TO RR BUSINESS VENTURES, LLC. THE POSSESSOR AGREES TO THE FOLLOWING

1. MAINTAIN THIS DOCUMENT IN CONFIDENCE
2. NOT TO REPRODUCE OR COPY IT
3. NOT TO REVEAL OR PUBLISH IT IN WHOLE OR PART

1

2

3

4