

1

2

3

4

Note:

1.Type C AB面接點需跟圖面一致.

REV	ECN#	DESCRIPTION OF REVISION	DRAW BY DATE	CHECK BY DATE	APPROVE BY DATE
A6	ECN-190853	Change Wire&Mylar Color	Lucas 09/03/19	Lucas 09/03/19	Ray 09/03/19

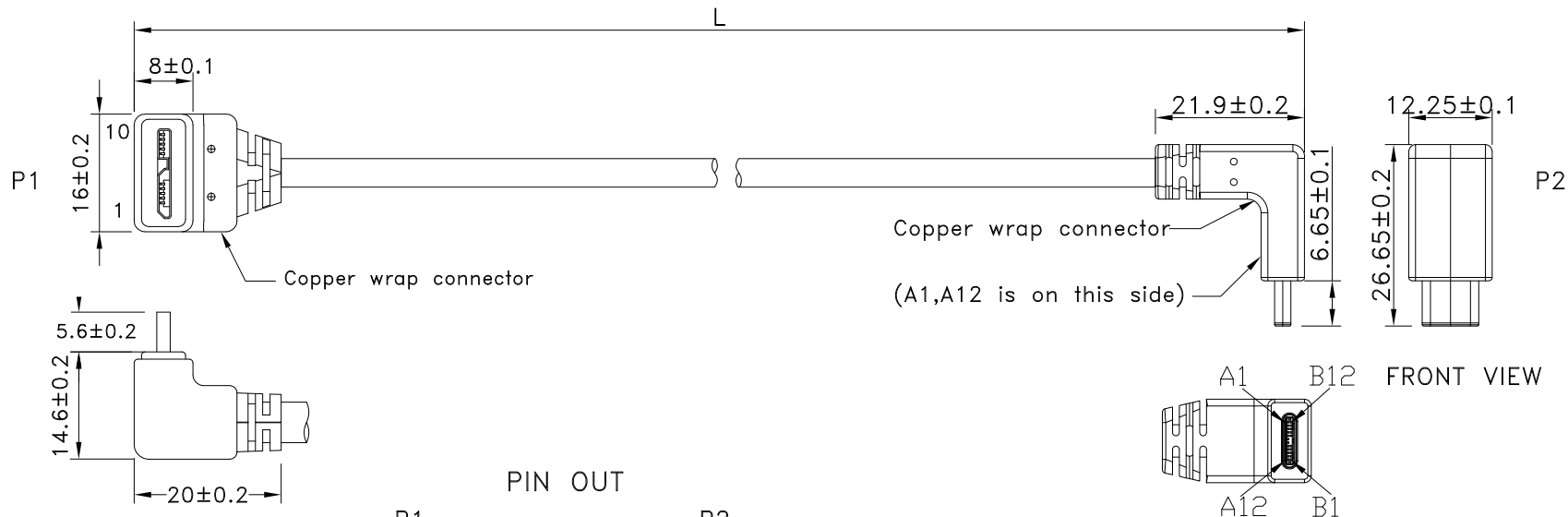

Micro USB BM  
RIGHT ANGLE UP  
MOLDED BLACK

PIN OUT

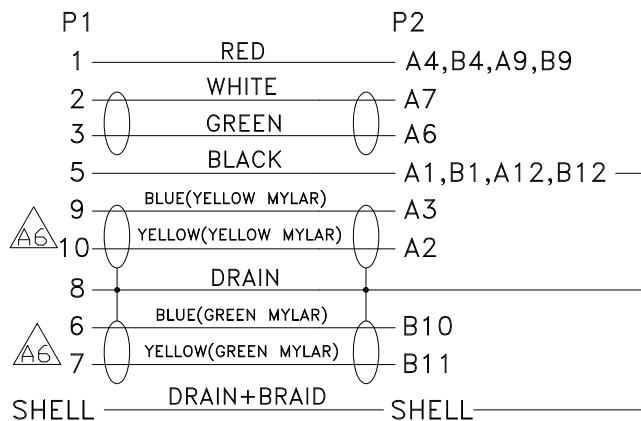

USB TYPE C M  
RIGHT ANGLE UP/DOWN  
MOLDED BLACK

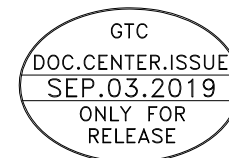

P/N	LENGTH
RR-MUCV-05GRA	127 <sup>+20</sup> <sub>-0</sub>
RR-MUCV-10GRA	255 <sup>+20</sup> <sub>-0</sub>
RR-MUCV-15GRA	381 <sup>+30</sup> <sub>-0</sub>
RR-MUCV-25GRA	635 <sup>+30</sup> <sub>-0</sub>
RR-MUCV-40GRA	1016 <sup>+40</sup> <sub>-0</sub>

TITLE	DRAWING NUMBER	REV.
USB3.0 Micro-BM RIGHT ANGLE UP TO USB3.1 C TYPE MALE RIGHT ANGLE UP/DOWN	RR-MUCV-XXGRA	A6

THIRD ANGLE PROJECTION	SIZE	SCALE	DRAW / DATE	CHECK / DATE	APPROVE / DATE	TOLERANCES	UNIT	SHEET
	B	1:1	Lucas 12/28/15	Ray 12/28/15	Ray 12/28/15	X.X ± 0.5 X.XX ± 0.2	X.XXX ± 0.05 ANGLES ± 1°	mm 1/3

THE INFORMATION CONTAINED HEREIN IS PROPRIETARY AND CONFIDENTIAL TO RR BUSINESS VENTURES, LLC. THE POSSESSOR AGREES TO THE FOLLOWING

1. MAINTAIN THIS DOCUMENT IN CONFIDENCE
2. NOT TO REPRODUCE OR COPY IT
3. NOT TO REVEAL OR PUBLISH IT IN WHOLE OR PART

1

2

3

4

1

2

3

4

REV	ECN#	DESCRIPTION OF REVISION	DRAW BY DATE	CHECK BY DATE	APPROVE BY DATE
A6	ECN-190853	Change Wire&Mylar Color	Lucas 09/03/19	Lucas 09/03/19	Ray 09/03/19

\*\*\*CONSTRUCTION:

1.CABLE: \* UL2725 (1P/30#+EAM)\*2+(1P/30#)+(2C/24#)+AEB(AL)65% OD:5.0mm  
BLACK PVC JACKET.

\*\*\*CONNECTOR:

2.Micro-USB B/M: \* MICRO-USB B "3.0" TYPE 10PIN MALE SOLDER TYPE.(SWEETRAY P/N:CHMICROUSB3BM01E)  
\* PINS: 30u GOLD PLATED OVER NICKEL.

\* SHELL: STEEL WITH GOLD FLASH .  
\* INSULATOR: BLACK COLOR P.B.T UL 94V-0 RATED.  
\* MOLDED BLACK PVC 45P.

3.USB C/M: \* USB TYPE C MALE SOLDER TYPE.  
\* PINS: 30u GOLD PLATED OVER NICKEL.  
\* INSULATOR: BLACK THERMOPLASTIC UL 94V-0.  
\* SHELL: STEEL WITH GOLD FLASH .  
\* RESISTOR(5.1KΩ) AND CAPACITOR.  
\* MOLDED: BLACK PVC 45P.

4.TEST: \* CT: 2 ohm IS: 5M ohm DC300V 0.1S.

5.PACKING: \* PACK EACH CABLE IN A POLY BAG AND 25PCS IN A POLY BAG.

6.MATERIAL: \* MATERIAL WITH RoHS GRADE.



TITLE USB3.0 Micro-BM RIGHT ANGLE UP TO USB3.1 C TYPE MALE RIGHT ANGLE UP/DOWN					DRAWING NUMBER RR-MUCV-XXGRA			REV. A6	
---	--	--	--	--	---------------------------------	--	--	------------	--

	B	1:1	Lucas 12/28/15	Ray 12/28/15	Ray 12/28/15	XX ± 0.5 X.XX ± 0.2	XXX ± 0.05 ANGLES ± 1°	mm	2/3
THIRD ANGLE PROJECTION	SIZE	SCALE	DRAW / DATE	CHECK / DATE	APPROVE / DATE	TOLERANCES		UNIT	SHEET



THE INFORMATION CONTAINED HEREIN IS PROPRIETARY AND CONFIDENTIAL TO RR BUSINESS VENTURES, LLC. THE POSSESSOR AGREES TO THE FOLLOWING  
1. MAINTAIN THIS DOCUMENT IN CONFIDENCE  
2. NOT TO REPRODUCE OR COPY IT  
3. NOT TO REVEAL OR PUBLISH IT IN WHOLE OR PART

1

2

3

4

1

2

3

4

REV	ECN#	DESCRIPTION OF REVISION	DRAW BY DATE	CHECK BY DATE	APPROVE BY DATE
A6	ECN-190853	Change Wire&Mylar Color	Lucas 09/03/19	Lucas 09/03/19	Ray 09/03/19

P/N	LENGTH(mm)	PE BAG(Inch)	PACKAGE
RR-MUCV-05GRA	127 <sup>+20</sup> <sub>-0</sub>	5.5"*10	(1)
RR-MUCV-10GRA	255 <sup>+20</sup> <sub>-0</sub>	5.5"*10	(2)
RR-MUCV-15GRA	381 <sup>+30</sup> <sub>-0</sub>	5.5"*10	(2)
RR-MUCV-25GRA	635 <sup>+30</sup> <sub>-0</sub>	5.5"*10	(2)
RR-MUCV-40GRA	1016 <sup>+40</sup> <sub>-0</sub>	5.5"*10	(2)

### PE BAG LABEL

RR-MUCV-XXGRA REV:XX  
 LOT: XXXX  
 Made in China

RR-MUCV-XXGRA REV:XX QTY:25PCS  
 LOT: XXXX  
 Made in China

### RoHS LABEL

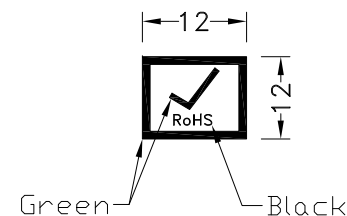

NOTES:PACK EACH CABLE IN A POLY BAG  
 AND 25PCS IN A POLY BAG.

#### PACK(1)

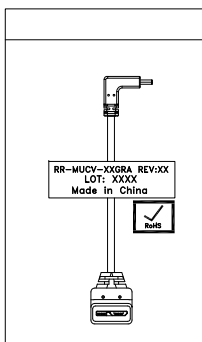

#### PACK(2)

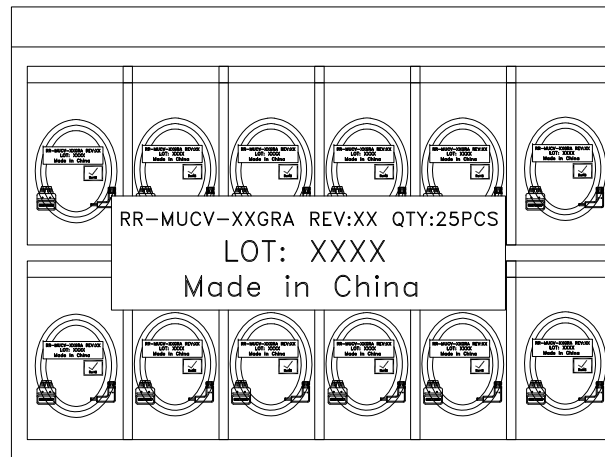
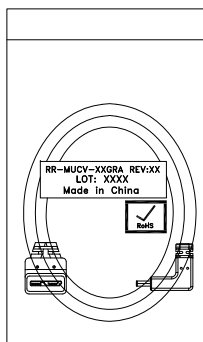

GTC  
 DOC.CENTER.ISSUE  
 SEP.03.2019  
 ONLY FOR  
 RELEASE

TITLE USB3.0 Micro-BM RIGHT ANGLE UP TO USB3.1 C TYPE MALE RIGHT ANGLE UP/DOWN						DRAWING NUMBER RR-MUCV-XXGRA			REV. A6	
THIRD ANGLE PROJECTION	SIZE	SCALE	DRAW / DATE	CHECK / DATE	APPROVE / DATE	TOLERANCES		UNIT	SHEET	
	B	1:1	Lucas 12/28/15	Ray 12/28/15	Ray 12/28/15	X.X ± 0.5 X.XX ± 0.2	X.XXX ± 0.05 ANGLES ± 1°	mm	3/3	

THE INFORMATION CONTAINED HEREIN IS PROPRIETARY AND CONFIDENTIAL TO RR BUSINESS VENTURES, LLC. THE POSSESSOR AGREES TO THE FOLLOWING

1. MAINTAIN THIS DOCUMENT IN CONFIDENCE
2. NOT TO REPRODUCE OR COPY IT
3. NOT TO REVEAL OR PUBLISH IT IN WHOLE OR PART

1

2

3

4